

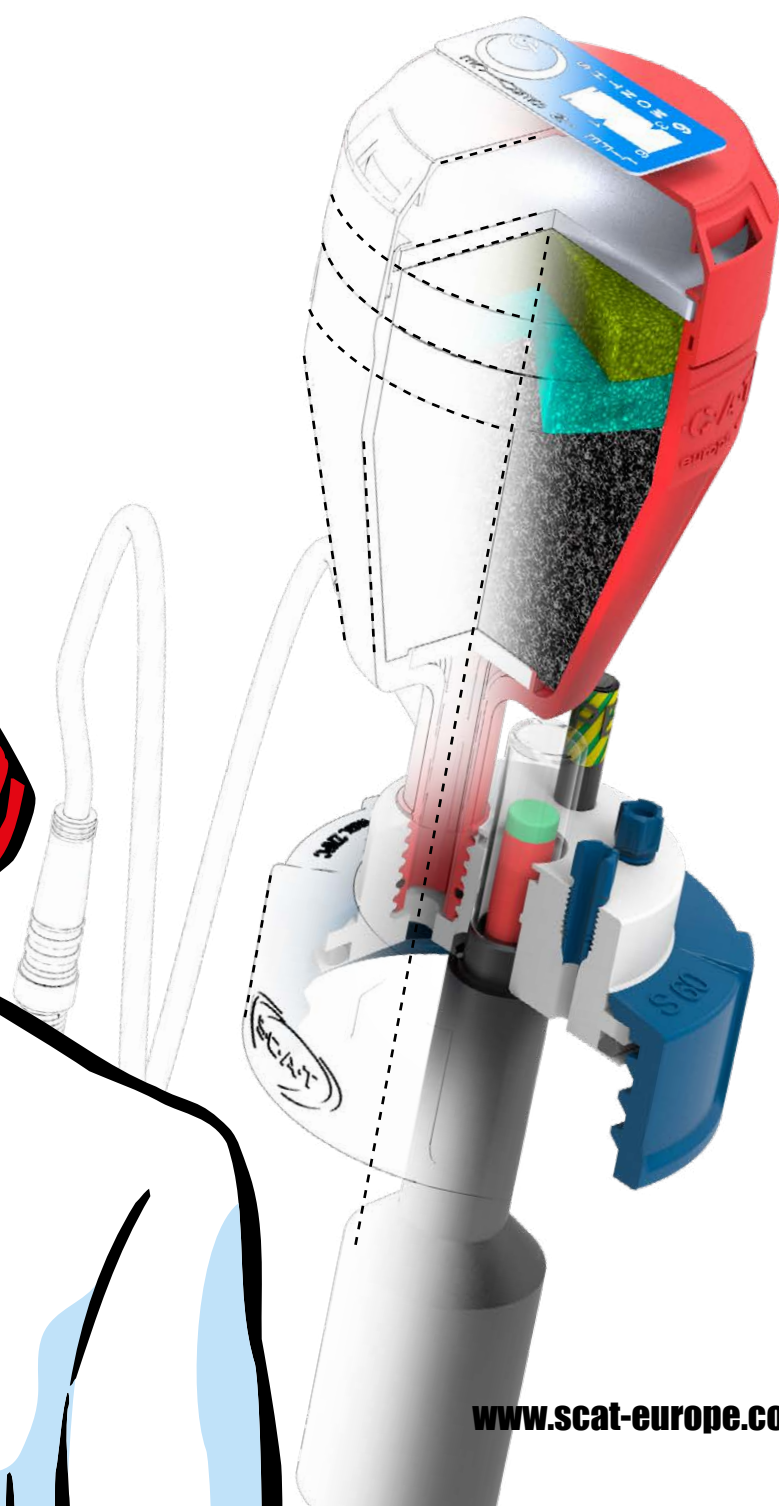

**THE No. 1 System
for Solvent Safety**

The next Level! **Safety Waste Caps 2.0**

Collect HPLC / UHPLC Waste safely.

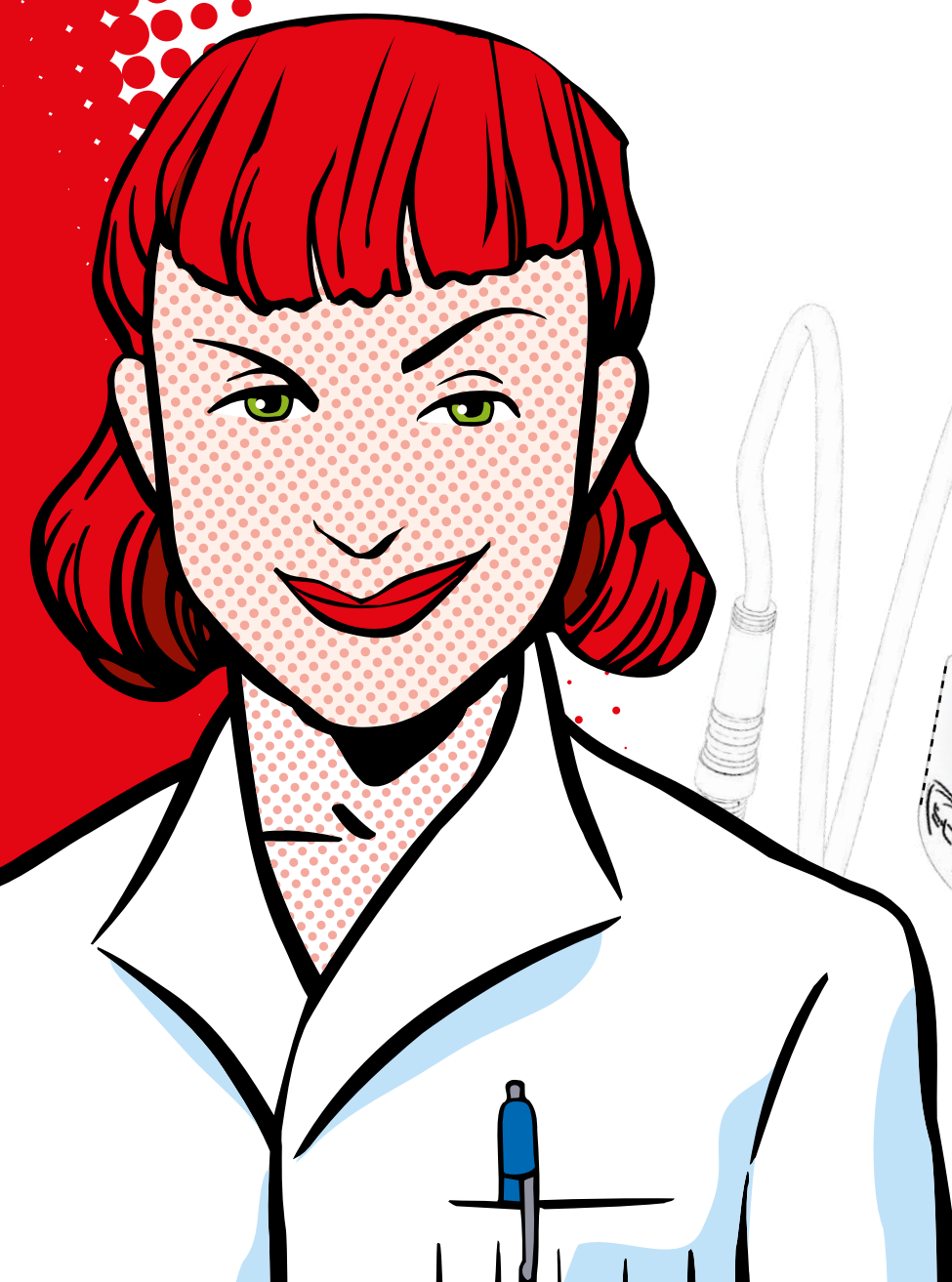

www.scat-europe.com

The next Level!



✓ Fire Protection

Housing made of partially crystalline PP with flammability classification V-0 (UL-94).

✓ Functional Layers!

For yet more safety, there are three different types of active carbon (layered), offering a broad spectrum of capabilities, as well as more functions, e.g. HPLC buffer solutions are now also bound:

3rd layer - binds acids

2nd layer - binds alkalis

1st layer - adsorbs solvent vapours

✓ > 90% CTC-Adsorption

The ability to bind has been increased by 20%!

✓ 1,500 m²/g

The inner adsorption surface area has been increased by 25%!



✓ PE-Pre-Filter

Protects the active carbon and provides optimal flow conditions for solvent vapours.



✓ Exhaust Filter with FKM Seal

Keeps the filter fixed tightly and prevents escape of solvent vapours.

✓ PE Filter Membrane

Stabilizes the active carbon and provides proper air permeability.

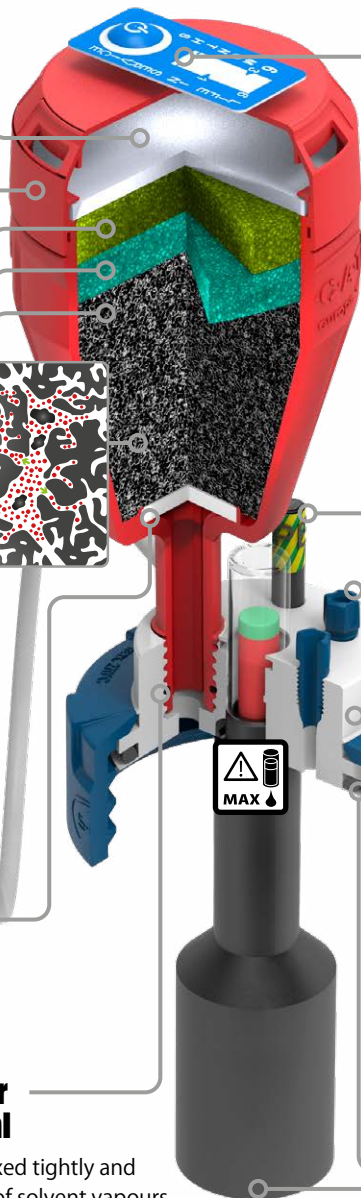

✓ Change indicator

Press the button to activate the countdown for the service life.



✓ Grounding connection

A grounding cable with a banana plug can be easily connected to this grounding connection.



✓ PFA Fittings

Improved design for easy tubing connection. Excellent chemical resistance. Flammability classification V-0 (UL-94)



✓ PPS Screw Cap

Autoclavable / sterilisable up to 200 °C. Flammability classification V-0 (UL-94).

✓ Medical Grade PTFE

Excellent chemical resistance. Food safe. FDA compliant. Flammability classification V-0 (UL-94).



✓ PTFE Body with integrated FKM Seal

Provides hermetical connection to the container opening and adapts smoothly even to rugged glass surfaces. An additional PTFE layer protects the seal from direct contact to solvents.

✓ Level Control

Floater and sight glass. Mechanical or electronic, shows the filling level of the used container.

Fire Protection / Flammability Classification according to UL-94

In case of fire, each second counts. Flame resistant materials can save lives and provide rescue teams with more time to react in case of an emergency. UL-94 is an international standard to classify the flammability of plastics. UL-94 can also be found in IEC/DIN EN 60695-11-10 and -20. V-0 is the highest classification with the following requirements to the plastic material:

- Burning stops within 10 seconds on a vertically fixed specimen.
- No drips of inflamed particles allowed.
- Maximum afterglow of 30 seconds.

Thread S 40 / GL 40, GL 45

 Standard connections for HPLC tubing with 1.6, 2.3, and 3.2 mm outer diameter. Fittings are included in the scope of delivery.

 Connections for larger tubing with 5 - 11.5 mm inner diameter. Tube connectors are included in the scope of delivery.

 Thread size of the screw caps: GL45 is the most common thread for solvent supply and waste bottles in laboratories. Find adapters for other thread sizes at: www.scateurope.com

 Mechanical level control with floater.

 Electronic level control with floater and signal cable for connecting with electronic signal boxes.

 Grounding connections. Additive protection from explosive mixtures of waste in waste containers.



Fig.	Part No.	Description	Thread	Connections for capillaries	Connections for tubes	LC mech.	LC electr.	Grounding conn.
	307 108	SWC S 40 / GL 40	S 40 / GL 40	3 x	-	-	-	-
	307 109	SWC S 40 / GL 40	S 40 / GL 40	2 x	1 x	-	-	-
A	307 912	SWC GL 45, V2.0	GL 45	3 x	-	-	-	-
B	307 923	SWC GL 45, V2.0	GL 45	2 x	1 x	-	-	-
C	308 921	SWC GL 45, V2.0	GL 45	4 x	1 x	-	-	-

Thread S 60/61

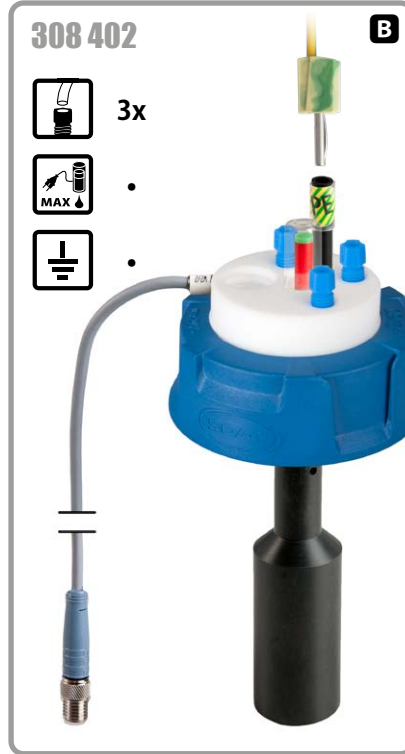

Fig.	Part No.	Description	Thread	Connections for capillaries	Connections for tubes	LC mech.	LC electr.	Grounding conn.
	307 500	SWC S 60/61, V2.0	S 60/61	3 x	3 x	-	-	-
	307 916	SWC S 60/61, V2.0	S 60/61	3 x	-	-	-	●
	307 918	SWC S 60/61, V2.0	S 60/61	3 x	-	-	-	-
	307 925	SWC S 60/61, V2.0	S 60/61	2 x	1 x	-	-	-
A	307 931	SWC S 60/61, V2.0	S 60/61	4 x	1 x	-	-	-
	307 944	SWC S 60/61, V2.0	S 60/61	2 x	1 x	-	-	●
	307 961	SWC S 60/61, V2.0	S 60/61	3 x	-	●	-	-
	307 964	SWC S 60/61, V2.0	S 60/61	2 x	1 x	●	-	-
B	308 402	SWC S 60/61, V2.0	S 60/61	3 x	-	-	●	●
	308 403	SWC S 60/61, V2.0	S 60/61	2 x	1 x	-	●	-
C	308 964	SWC S 60/61, V2.0	S 60/61	2 x	1 x	●	-	●

Thread S65

Safety Waste Caps 2.0



Fig.	Part No.	Description	Thread	Connections for capillaries	Connections for tubes	LC mech.	LC electr.	Grounding conn.
	107 969	SWC S 65	S 65	4 x	1 x	●	-	-
A	108 046	SWC S 65	S 65	5 x	-	-	-	-
B	108 047	SWC S 65	S 65	4 x	1 x	-	-	-
	108 055	SWC S 65	S 65	4 x	1 x	-	-	●
C	108 203	SWC S 65	S 65	2 x	1 x	-	●	-

Thread B 53, B 63



Fig.	Part No.	Description	Thread	Connections for capillaries	Connections for tubes	LC mech.	LC electr.	Grounding conn.
	107 037	SWC B 53	B 53	4 x	1 x	-	-	-
A	107 054	SWC B 53	B 53	3 x	1 x	-	-	•
	107 245	SWC B 53	B 53	1 x	1 x	•	-	-
B	107 246	SWC B 53	B 53	1 x	1 x	-	•	-
	107 038	SWC B 63	B 63	1 x	3 x	-	-	-
	107 050	SWC B 63	B 63	2 x	1 x	-	-	-
	107 051	SWC B 63	B 63	3 x	-	-	-	-
C	107 247	SWC B 63	B 63	2 x	1 x	•	-	-
	107 248	SWC B 63	B 63	2 x	1 x	-	•	-

Thread B 83

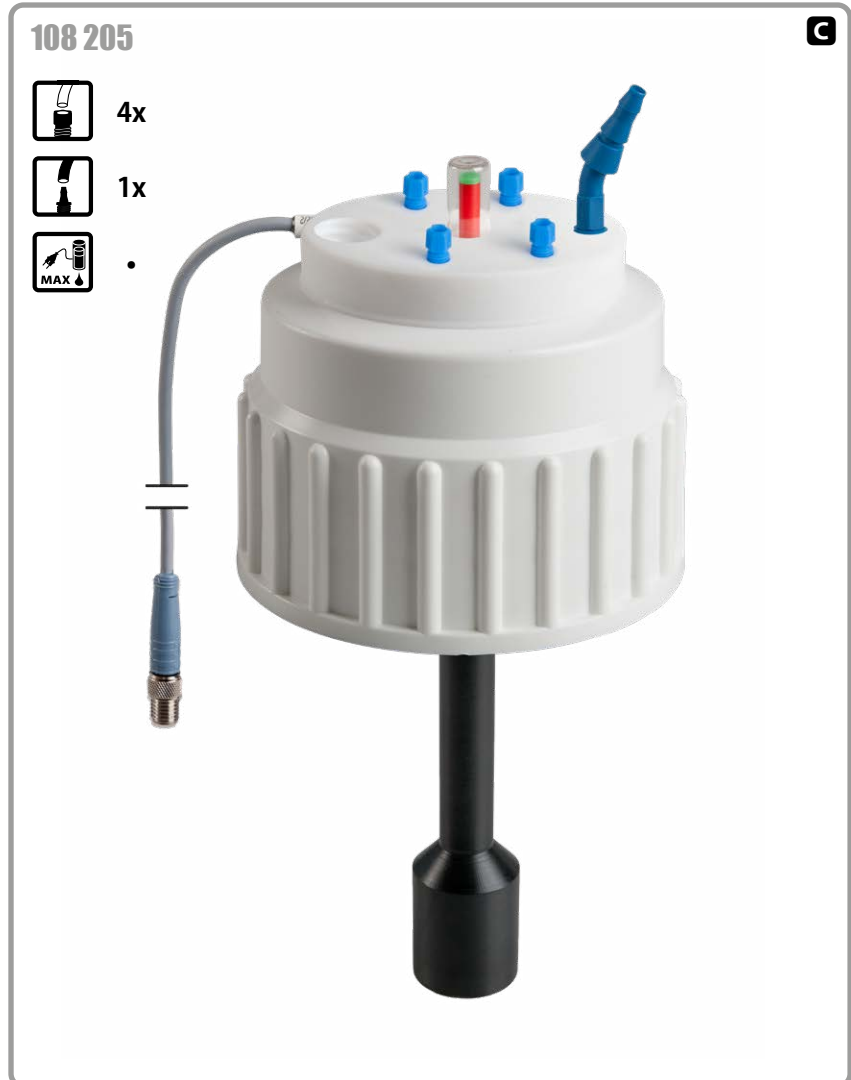
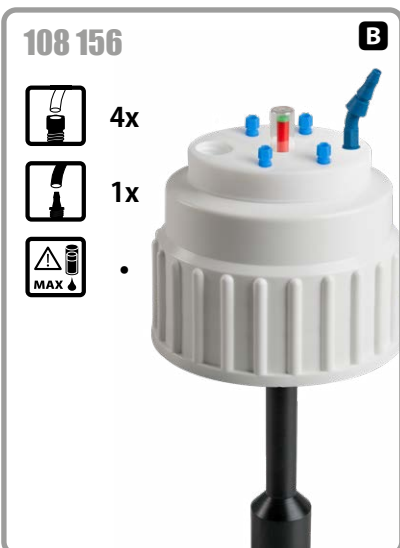
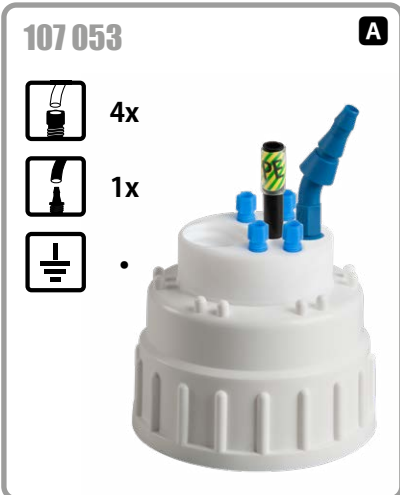

Fig.	Part No.	Description	Thread	Connections for capillaries	Connections for tubes	LC mech.	LC electr.	Grounding conn.
	107 034	SWC B 83	B 83	4 x	1 x	-	-	-
	107 036	SWC B 83	B 83	4 x	-	-	-	-
	107 052	SWC B 83	B 83	4 x	-	-	-	•
A	107 053	SWC B 83	B 83	4 x	1 x	-	-	•
B	108 156	SWC B 83	B 83	4 x	1 x	•	-	-
C	108 205	SWC B 83	B 83	4 x	1 x	-	•	-

Thread S 50, S51



Fig.	Part No.	Description	Thread	Connections for capillaries	Connections for tubes	LC mech.	LC electr.	Grounding conn.
	108 023	SWC S 50	S 50	3 x	-	-	-	-
	108 024	SWC S 50	S 50	3 x	-	-	-	•
	108 025	SWC S 50	S 50	2 x	1 x	-	-	-
A	108 026	SWC S 50	S 50	2 x	1 x	-	-	•
	107 241	SWC S 51	S 51	2 x	-	•	-	-
B	107 242	SWC S 51	S 51	2 x	-	-	•	-
	107 922	SWC S 51	S 51	2 x	1 x	-	-	-
	107 930	SWC S 51	S 51	3 x	-	-	-	-
C	107 935	SWC S 51	S 51	3 x	-	-	-	•
	107 942	SWC S 51	S 51	2 x	1 x	-	-	•

Thread S 55

Safety Waste Caps 2.0

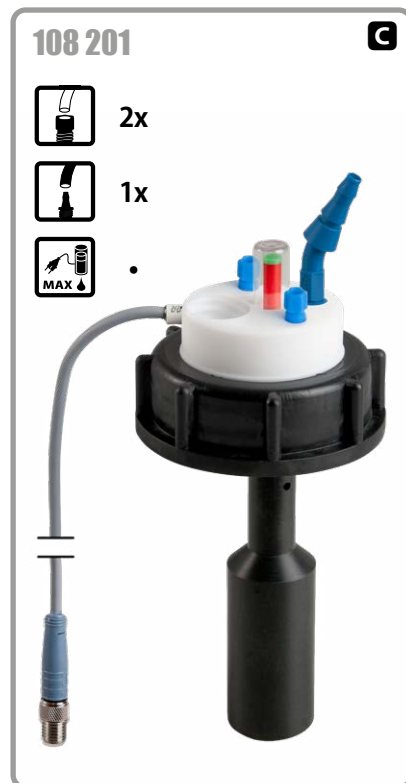

Fig.	Part No.	Description	Thread	Connections for capillaries	Connections for tubes	LC mech.	LC electr.	Grounding conn.
	107 917	SWC S 55	S 55	3 x	-	-	-	-
A	107 924	SWC S 55	S 55	2 x	1 x	-	-	-
	107 936	SWC S 55	S 55	3 x	-	-	-	•
B	107 943	SWC S 55	S 55	2 x	1 x	-	-	•
	107 960	SWC S 55	S 55	3 x	-	•	-	-
	107 963	SWC S 55	S 55	2 x	1 x	•	-	-
	108 030	SWC S 55	S 55	3 x	-	-	-	•
	108 200	SWC S 55	S 55	3 x	-	-	•	-
C	108 201	SWC S 55	S 55	2 x	1 x	-	•	-

Thread S 70/71, S 90



Fig.	Part No.	Description	Thread	Connections for capillaries	Connections for tubes	LC mech.	LC electr.	Grounding conn.
	107 913	SWC S 70/71	S 70/71	3 x	-	-	-	-
	107 915	SWC S 70/71	S 70/71	3 x	-	-	-	●
	107 926	SWC S 70/71	S 70/71	2 x	1 x	-	-	-
A	107 945	SWC S 70/71	S 70/71	2 x	1 x	-	-	●
	107 962	SWC S 70/71	S 70/71	3 x	-	●	-	-
	107 965	SWC S 70/71	S 70/71	2 x	1 x	●	-	-
	108 407	SWC S 70/71	S 70/71	2 x	1 x	-	●	-
	107 928	SWC S 90	S 90	4 x	-	-	-	●
	107 947	SWC S 90	S 90	4 x	1 x	-	-	-
	107 949	SWC S 90	S 90	4 x	1 x	-	-	●
	107 966	SWC S 90	S 90	4 x	-	●	-	-
	107 967	SWC S 90	S 90	4 x	1 x	●	-	-
	108 031	SWC S 90	S 90	4 x	-	●	-	●
B	108 231	SWC S 90	S 90	4 x	1 x	-	●	-

Thread GLS 80, S 95

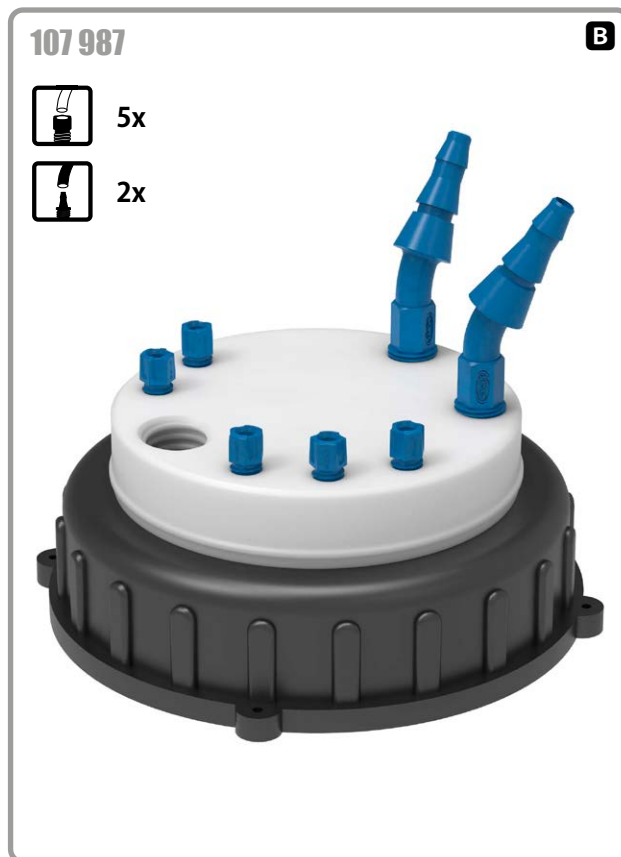

Fig.	Part No.	Description	Thread	Connections for capillaries	Connections for tubes	LC mech.	LC electr.	Grounding conn.
A	107 029	SWC GLS 80	GLS 80	4 x	-	-	-	-
	107 033	SWC GLS 80	GLS 80	4 x	1 x	-	-	-
	107 256	SWC S 95	S 95	4 x	-	-	-	-
	107 257	SWC S 95	S 95	1 x	1 x	-	-	-
	107 258	SWC S 95	S 95	4 x	1 x	●	-	-
	107 259	SWC S 95	S 95	4 x	1 x	-	●	-
B	107 987	SWC S 95	S 95	5 x	2 x	-	-	-



SCAT - Europe GmbH

Waldecker Straße 7
64546 Mörfelden-Walldorf
Germany

 **+49 (0) 61 05 / 30 55 86 - 0**

 **+49 (0) 61 05 / 30 55 86 - 99**

 **info@scat-europe.com**

 **www.scat-europe.com**



SCAT - Americas, Inc.

1704 East Blvd., Suite 101
Charlotte, NC 28203
USA

 **+1.704.438.9477**

 **+1.704.373.2603**

 **info@scat-americas.com**

 **www.scat-americas.com**

